

Novità —
Gennaio 2016.
Caiigo,
Lumiere xxl + xxs,
Tress, Troag.

FOSCARINI



Indice — *Index*

Caiigo

Marco Zito → p. 004

Lumiere xxi + xxs

Rodolfo Dordoni → p. 010

Tress

Marc Sadler → p. 018

Troag

Luca Nichetto → p. 032

Traduzioni — *Translations*

p. 040

Legenda — *Key*

p. 046

Sospensione, *Suspension*



Novità — Gennaio 2016

005

Lampada da sospensione — *Suspension lamp*

Caiigo

Marco Zito, 2015

La foschia che si alza al mattino dalla laguna, rivelando una luminosità rarefatta e sognante, è la visione ispiratrice della lampada a sospensione Caiigo.

The mist which rises from the lagoon in the morning gives way to a rarefied, dreamlike light, a vision which inspired the Caiigo suspension lamp.

Atmosphere

Caiigo — Marco Zito, 2015

“Caiigo” in dialetto veneziano significa nebbia e dalla millenaria tradizione della città lagunare nasce anche il vetro soffiato utilizzato per il diffusore. Il suo caratteristico effetto sfumato, fra il bianco e il trasparente, è determinato dalla sapienza artigianale del maestro vetraio che rende unica ogni singola lampada.

In Venetian dialect caiigo means fog and the blown glass used for the lamp’s diffuser emerged from a tradition which stretches back a thousand years in this lagoon city. Its characteristic nuanced effect, somewhere between white and transparent, is the result of the artisan expertise of master glass-makers who make every single lamp unique.

Uniqueness

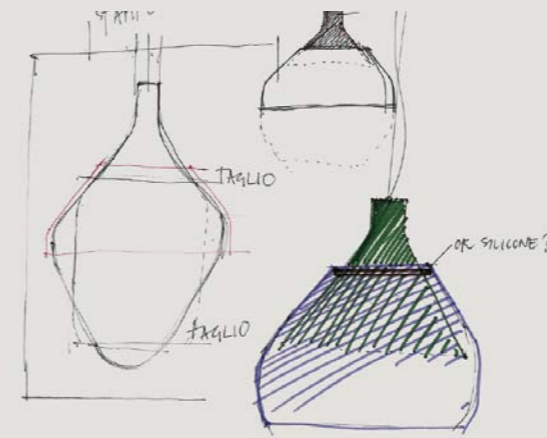
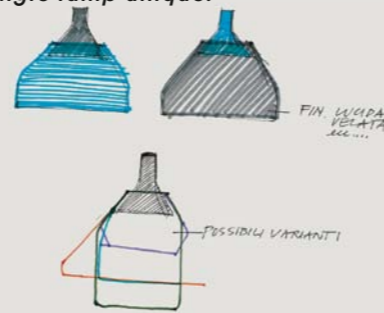

La magia e il valore del processo artigianale rende poetica la tecnologia LED, che irradia una luminosità ottimale verso il basso, fondendosi perfettamente con l’emozione preziosa del vetro soffiato. Suggestiva sia da spenta sia da accesa, capace di evocare sensazioni della memoria e della natura, Caiigo è una protagonista versatile nel paesaggio domestico come negli scenari contract: da sola o in composizioni lineari oppure a grappolo.

Its magic and the artisan process which made it gives a touch of poetry to its LED light which shines optimally downwards melding perfectly with its precious blown glass. Evocative both off and on, capable of bringing sensations from memory and nature to mind, Caiigo is a versatile centre stage element both at home and in contract settings, on its own, in linear compositions or grouped together.

Textes en français, deutsche Texte, textos en español → p. 042

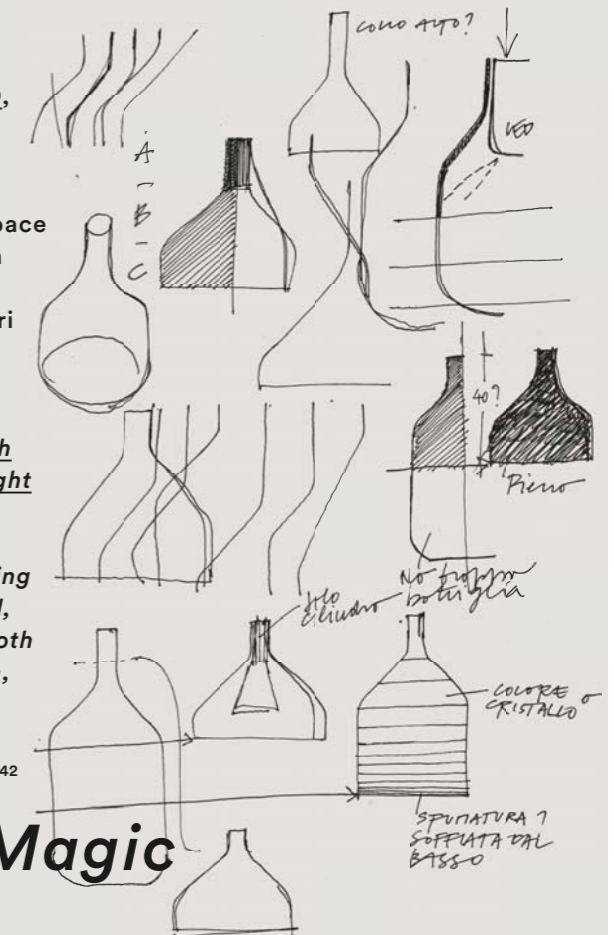

Magic



Caiigo

Marco Zito, 2015



Vetro soffiato e alluminio.
Blown glass and aluminium.

LED retrofit 1x8W GU10
halo 1x35W GU10
Energy class A++, A+, A, B, C

⊕ ⚡ IP 20

Trasparente e bianco sfumato.
Transparent and fading white.

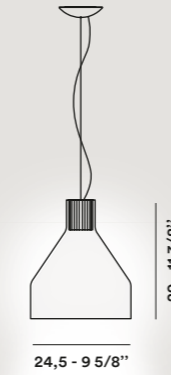

Lampada da tavolo e da terra — *Floor and table lamp*

Lumiere **xxl+xxs**

Rodolfo Dordoni, 2009/2015



Era il 1990 quando il designer Rodolfo Dordoni proponeva a Foscarini una rilettura colta, elegante e creativa della classica abat-jour. Da quell'incontro nacque Lumiere, ancora oggi best seller della collezione e icona nel panorama del design contemporaneo. La prima Lumiere ha poi ispirato le versioni **xxl** e **xxs**, una rilettura del progetto originale, dalle proporzioni nuove e dal segno più deciso.

It was back in 1990 when the designer Rodolfo Dordoni presented Foscarini with the proposal for a refined, elegant and creative reinterpretation of the classic bedside lamp. From that meeting, Lumiere was born, which is still one of the collection's best sellers and has since become an icon in the contemporary design field. The first Lumiere went on to inspire the **xxl** and **xxs** versions, a reinterpretation of the original project, with new proportions and a stronger design.

Contemporary classic



Oggi Lumiere xxl e xxs si presenta in una veste rinnovata, con colori attuali che ne sottolineano l'eleganza ricercata e la avvicinano ai toni degli arredi contemporanei. Accanto al bianco di sempre, grigio freddo e marrone freddo sono le raffinate proposte per il paralume in vetro soffiato a bocca, in abbinamento alle nuove finiture alluminio o cromo nero per la montatura.

Today, Lumiere xxl and xxs have been revamped, with modern colours emphasizing their refined elegance and bringing them closer to the tones of contemporary furnishings. Next to the classic white version, refined cold grey and cold brown colours are now available for the blown glass shade, in conjunction with new aluminium or black chrome finishes for the frame.

Sophisticated

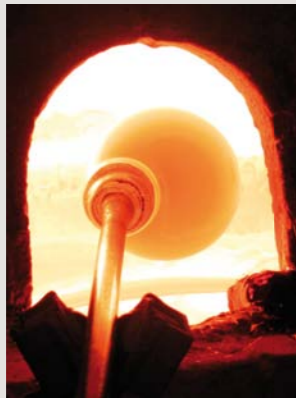
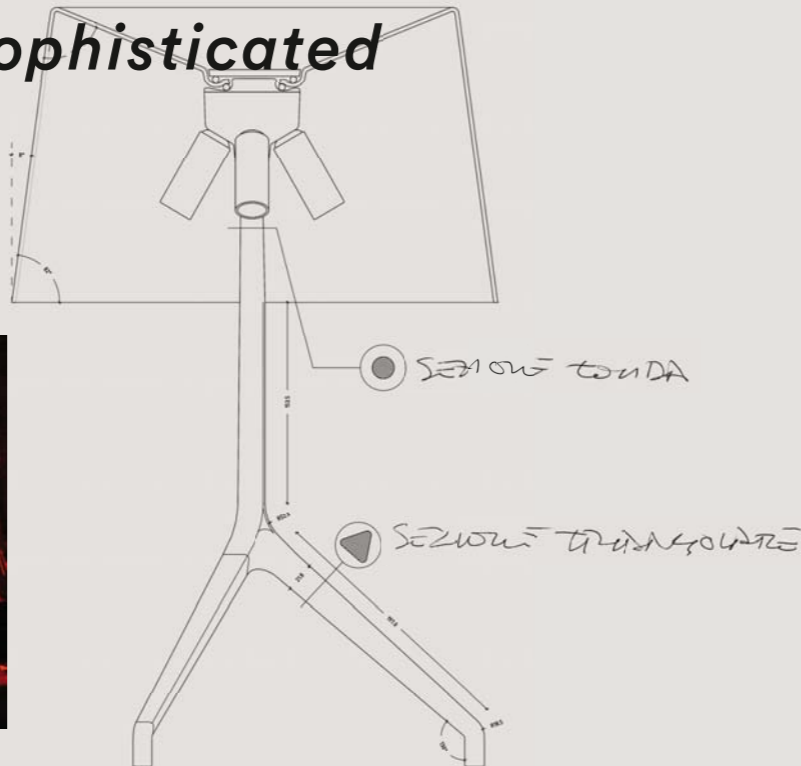

Lumiere xxl + xxs — Rodolfo Dordoni, 2009/2015



Espressione di una ricerca completamente nuova nelle proporzioni, nelle dimensioni e nel linguaggio estetico è invece la nuova Lumiere xxl lettura. Mantenendo il dualismo fra il diffusore in vetro soffiato e la base in metallo, si coordina alla nuova palette della versione da tavolo ma ne ridisegna l'armonia, creando una nuova presenza nello spazio. Importante ma non invadente, elegante ma non ostentata, è particolarmente adatta agli ambienti living.

The new Lumiere xxl reading lamp is instead an expression of entirely new research in terms of proportions, size and aesthetic language. It keeps the dualism between the blown glass diffuser and the metal base, is coordinated with the new colours of the table version, but it completely redesigns its forms and harmony, creating a new presence in the room. Important but not intrusive, elegant but not ostentatious, it is particularly well-suited for living areas.

Textes en français, deutsche Texte, textos en español → p. 042

New harmony



Lumiere xxl + xxs

Rodolfo Dordoni, 2009

Lumiere xxl



37 - 14 9/16"

Lumiere xxs



26 - 10 1/4"

57 - 22 7/16"

40 - 15 3/4"

Vetro soffiato e alluminio o cromo nero.
Blown glass and aluminium or black chrome.

Lumiere xxl
220 / 240V: halo 4x33W G9
120V: halo 4x40W G9

Lumiere xxs
220 / 240V: halo 1x48W G9
120V: halo 1x40W G9

Energy class C

Dimmer incluso — *Dimmer included*

☐ ⚡ IP 20

Vetro: bianco, grigio freddo, marrone freddo.
Glass: white, cool grey, cool brown.
Montatura: alluminio, cromo nero.
Frame: aluminium, black chrome.

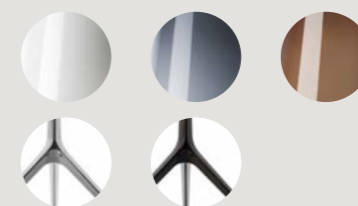

Lumiere xxl

Rodolfo Dordoni, 2015

37 - 14 9/16"



22 - 8 1/2"

144 - 56 11/16"

32 - 12 1/2"

Vetro soffiato e alluminio.
Blown glass and aluminium.

Lumiere xxl
220 / 240V: halo 4x33W G9
120V: halo 4x40W G9
Energy class C

Dimmer incluso — *Dimmer included*

☐ ⚡ IP 20

Vetro: bianco, grigio freddo, marrone freddo.
Glass: white, cool grey, cool brown.
Montatura: alluminio, cromo nero.
Frame: aluminium, black chrome.

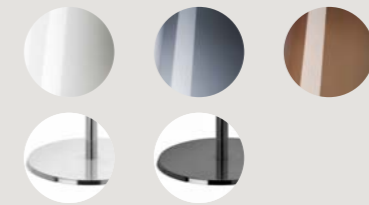

Lampada da tavolo, terra e sospensione — Table, floor and suspension lamp



Tress è un intreccio che diventa al tempo stesso struttura portante e decoro, dando forma a un'idea di illuminazione originale, che è già un'icona nel panorama del design della luce.

Tress is a weave and at the same time a supporting structure and decoration, giving shape to an original lighting idea, which has already become an icon in the lighting design field.

Original

Tress — Marc Sadler, 2008/2009

Puro gioco di pieni e di vuoti, luci e ombre, Tress è ottenuta con un processo artigianale. Dall'avvolgimento di nastri in materiale composito, seguendo un pattern apparentemente casuale, si ottiene una forma che porta nello spazio un'atmosfera calda e magica.

A pure interplay of full and empty spaces, light and shadow, Tress is the result of a handcrafted process. By weaving strips of composite material, following a seemingly random pattern, a shape is created that brings a warm and magical atmosphere into the room.

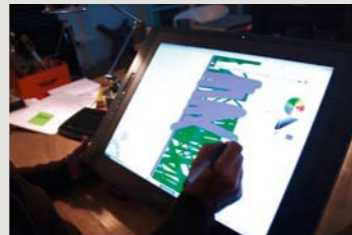
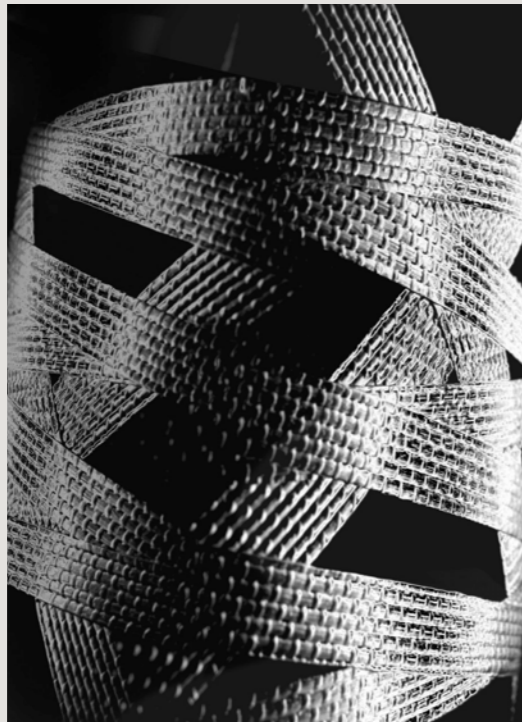
Handcrafted

Oggi questo progetto si veste di nuove tonalità. Vulcanica in rosso cremisi, sorprendente in blu indaco ed estremamente attuale in greige – un tono tra il grigio ed il beige – Tress porta nuove nuance nelle case e negli spazi collettivi. Ai nuovi colori si affiancano il bianco ed il nero, componendo una scelta fra cinque diverse possibilità, ognuna con un fascino particolare. Il risultato è un'ampia famiglia di lampade, particolarmente adatta a grandi composizioni multiple o a progetti di illuminazione coordinati.

Today this model is available in a new range of colours. Volcanic in crimson red, surprising in indigo blue and extremely contemporary in greige – a shade between grey and beige - Tress brings new nuances to homes and public spaces. The new colours are also accompanied by black and white versions, making a total of five different possibilities to choose from - each with their own special charm. The result is a large family of lamps, particularly suitable for multiple installations or coordinated lighting projects.

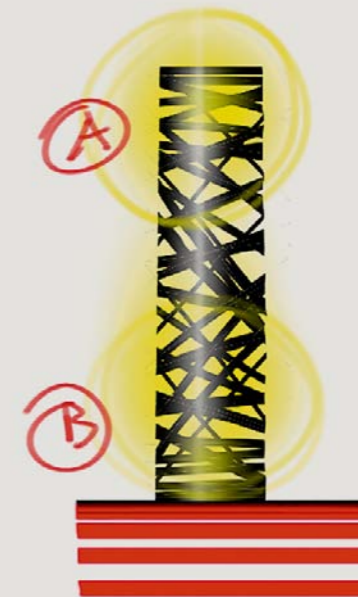

Textes en français, deutsche Texte, textos en español → p. 044

Up-to-date colors



Tress

Marc Sadler, 2008



Tress grande

Tress media



Materiale composito su base di fibra di vetro laccato, metallo verniciato e alluminio.
Compound material on lacquered glass fibre base, varnished metal and aluminium.

Tress grande
220 / 240V: LED included 56W 3000° K 3721 lm
120V: LED included 46W 3000° K 3193 lm
Energy class A

220 / 240V: halo 1x100W E27 + halo 1x230W R7s
120V: halo 1x75W E26 + halo 1x300W RSC
Energy class C

Dimmer incluso, doppia accensione
— Dimmer included, double switch

Tress media
220 / 240V: halo 1x100W E27
120V: halo 1x75W E26
Energy class C

Dimmer incluso — Dimmer included

☐ ⚡ IP 20 — © (halo grande)

Bianco, nero, cremisi, greige, indaco.
White, black, crimson, greige, indigo.

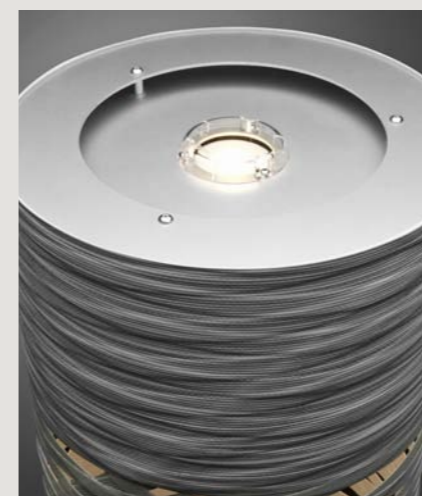
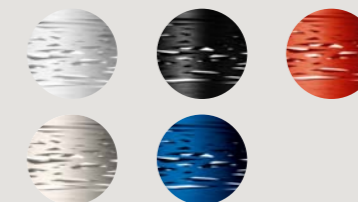

Tress

Marc Sadler, 2009

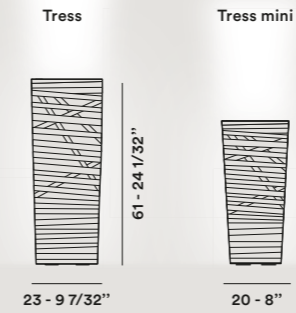

Materiale composito su base di fibra di vetro verniciato.
Varnished fibreglass based composite material.

Tress
220 / 240V: halo 1x100W E27
120V: halo 1x75W E26

Tress mini
220 / 240V: halo 1x75W GU10
120V: halo 1x75W GU10

Energy class C

Dimmer incluso — *Dimmer included*

☐ IP 20

Bianco, nero, cremisi, greige, indaco.
White, black, crimson, greige, indigo.

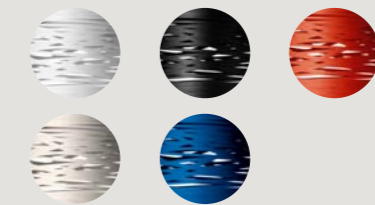

Tress grande

Marc Sadler, 2009

LED



Materiale composito su base di fibra di vetro verniciato, vetro soffiato acidato e alluminio.
Coated fibreglass based composite material, blown acid-etched glass and aluminium.

LED 35W 3000° K 3062 lm included
Energy class A+

220 / 240V: halo 1x160W R7s
120V: halo 1x200W RSC
Energy class C

   IP 20 —  (halo)

Dimmerabile — *Dimmable*

Bianco, nero, cremisi, greige, indaco.
White, black, crimson, greige, indigo.

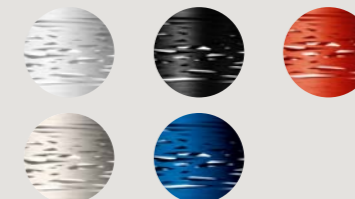

Tress

Marc Sadler, 2009

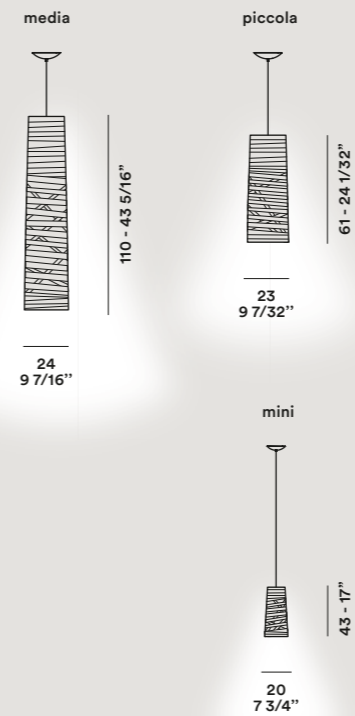

Materiale composito su base di fibra di vetro verniciato e metallo cromato.
Varnished fibreglass based composite material and chromed metal.

Tress media / piccola
220 / 240V: LED retrofit/fluoro 1x12W E27
halo 1x100W E27
120V: LED retrofit/fluoro 1x12W E26
halo 1x75W E26

Tress mini
220 / 240V: LED retrofit/fluoro 1x8W GU10
halo 1x75W GU10
120V: LED retrofit/fluoro 1x8W GU10
halo 1x75W GU10

Energy class A+, A, B, C

⊕ ⚡ Ⓛ LED IP 20 — Ⓢ (media / piccola)

Bianco, nero, cremisi, greige, indaco.
White, black, crimson, greige, indigo.





Rosone multiplo — Multiple canopy

Tondo — Round

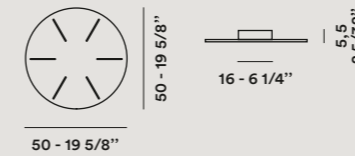

Metallo verniciato. *Lacquered metal.*

Round

Tress mini → max 9
Tress media → max 5
Tress piccola → max 9

Lineare — Linear

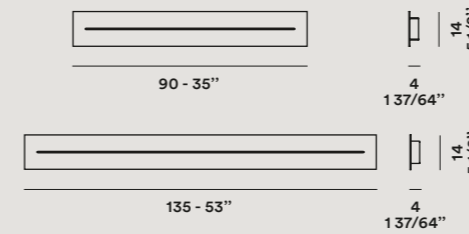

Linear L 90 - 35"

Tress mini → max 9
Tress media → max 5
Tress piccola → max 9

Linear L 135 - 53"

Tress mini → max 9
Tress media → max 5
Tress piccola → max 9

Il massimo si riferisce all'installazione di lampade in composizione sfalsata. *Max refers to installation in staggered composition.*





Lampada da sospensione — *Suspension lamp*

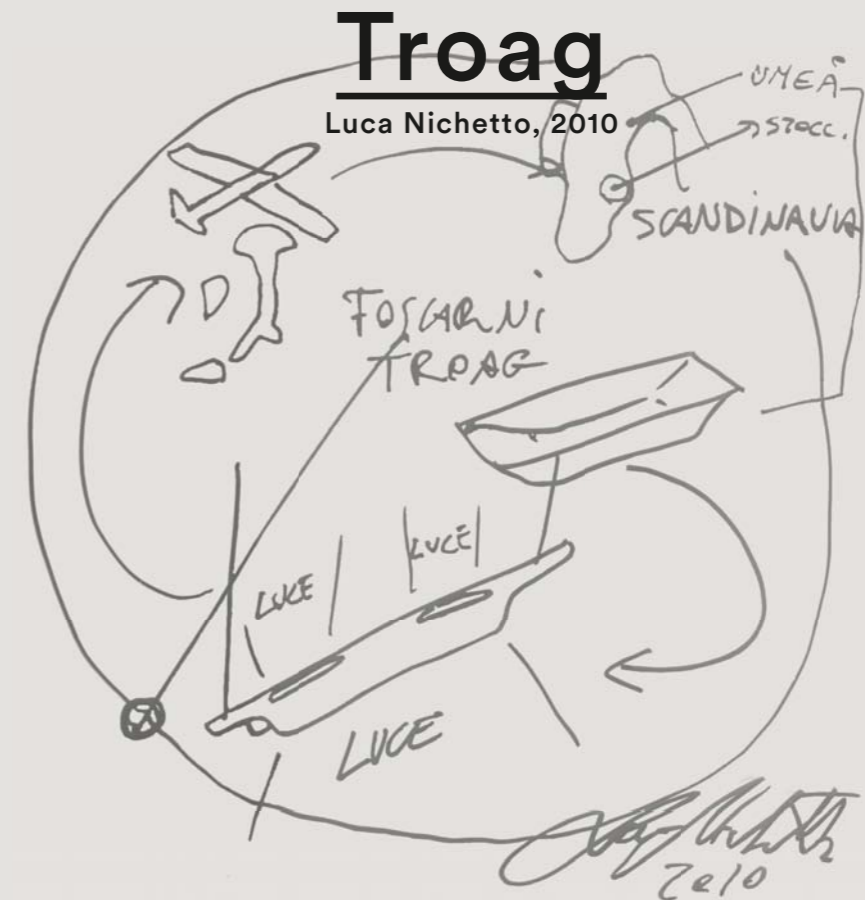

Nel nome e nella forma, Troag si ispira ad una ciotola in legno della tradizione scandinava, un oggetto familiare e quotidiano. Un'ispirazione ricontestualizzata da Foscarini e Luca Nichetto con creatività, ricerca tecnologica e cura della realizzazione tipicamente italiane.

In both its name and its shape, Troag takes inspiration from a traditional Scandinavian wooden bowl, a familiar and everyday object. An inspiration that has been recontextualized by Foscarini and Luca Nichetto using typical Italian creativity, technological research and close attention to detail in the production phase.

Nordic soul



Troag — Luca Nichetto, 2010

Lampada a sospensione dal segno leggero e lineare, Troag veste una luce tecnica con il calore del legno. Il diffusore è infatti realizzato in multistrato curvato a caldo e lavorato sui bordi con una particolare fresatura. Disponibile in tre diverse misure, Troag sfrutta al meglio la luminosità del tubo fluorescente all'interno, proiettando verso il basso una luce calda e uniforme, che non abbaglia grazie a uno schermo protettivo.

A suspension lamp with a light and linear design, Troag covers a technical light with the warmth of wood. The diffuser is in fact made from heat-curved plywood, with special milling applied to the edges. Available in three different sizes, Troag makes the most of the brightness provided by the inner fluorescent tube, casting a warm and uniform downward light, without any glare thanks to a protective screen.

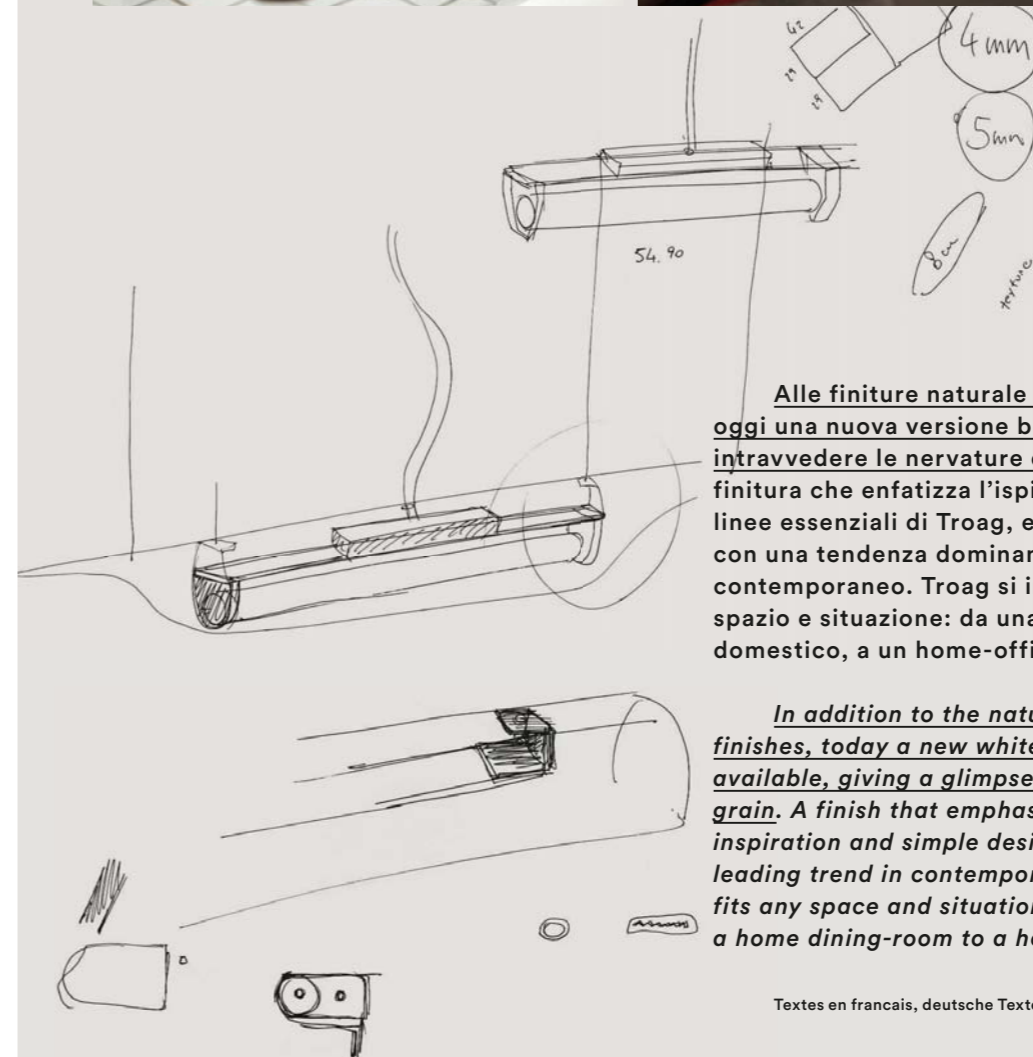
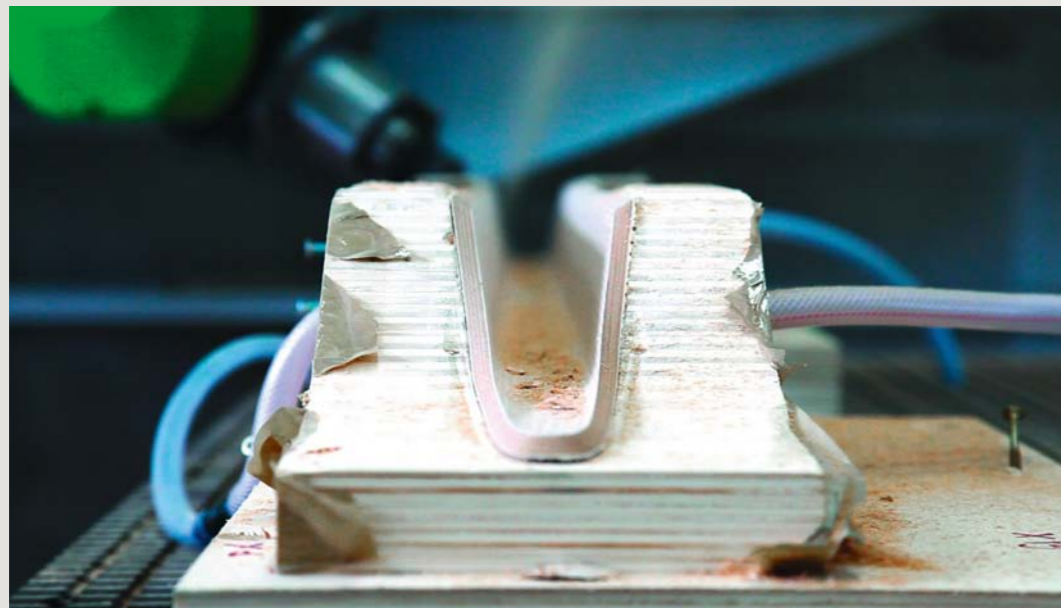
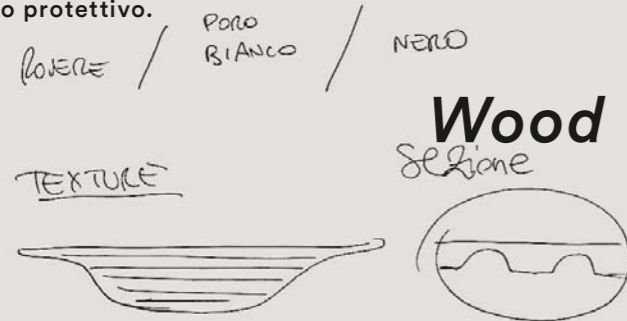

Alle finiture naturale e nera, si aggiunge oggi una nuova versione bianca, che lascia intravedere le nervature del legno. Una finitura che enfatizza l'ispirazione nordica e le linee essenziali di Troag, entrando in sintonia con una tendenza dominante nell'arredo contemporaneo. Troag si inserisce in ogni spazio e situazione: da una cucina a un dining domestico, a un home-office.

In addition to the natural and black finishes, today a new white version is also available, giving a glimpse of the wood's grain. A finish that emphasizes Troag's Nordic inspiration and simple design, in tune with a leading trend in contemporary furnishings. Troag fits any space and situation: from a kitchen to a home dining-room to a home-office.

Textes en français, deutsche Texte, textos en español → p. 044

Home-office

Troag

Luca Nichetto, 2010

Multistrato di legno curvato e PMMA.
Curved plywood and PMMA.

Troag grande
220 / 240 - 120V: fluo 1x80W G5

Troag media
220 / 240 - 120V: fluo 1x54W G5

Troag piccola
220 / 240 - 120V: fluo 1x24W G5

Energy class A+, A



Nero, naturale, bianco.
Black, natural, white.



grande

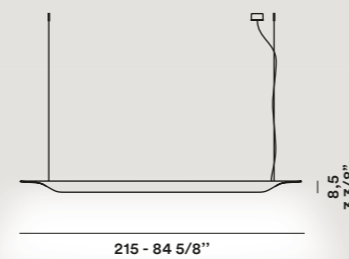

media

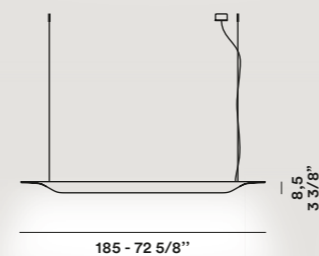

piccola

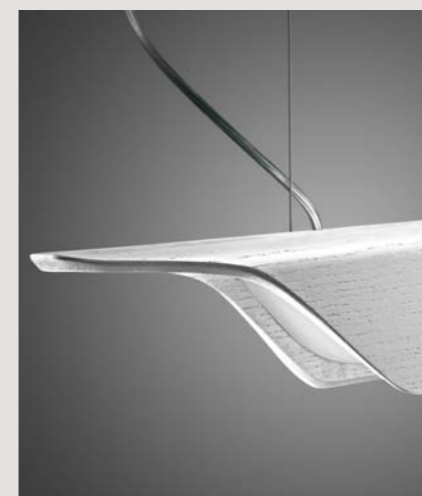
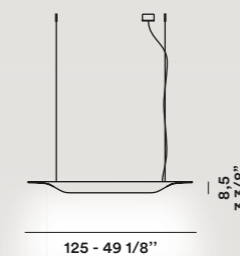

*Textes en français — Deutsche Texte
— Textos en español*

004 **Caiigo**
010 **Lumiere xxl**
+ xxs

018 **Tress**
032 **Troag**





Caiigo —
Marco Zito, 2015
p. 004

FR → La brume qui se lève le matin de la lagune, révélant une luminosité raréfiée et rêveuse, c'est la vision inspiratrice de la lampe à suspension Caiigo. En patois vénitien, "Caiigo" signifie brouillard et de la tradition millénaire de la ville lagunaire, naît aussi le verre soufflé utilisé pour le diffuseur. Son effet caractéristique nuancé, entre le blanc et le transparent, est déterminé par le savoir artisanal du maître verrier qui rend chaque lampe unique. La magie et la valeur du procédé artisanal rend poétique la lumière LED qui s'irradie de manière optimale vers le bas, se fondant parfaitement avec la précieuse émotion du verre soufflé. Séduisante aussi bien éteinte qu'allumée, capable d'évoquer les sensations de la mémoire et de la nature, Caiigo est une protagoniste polyvalente dans le paysage domestique comme dans les décors contract : seule ou dans des compositions linéaires ou en grappe.

DE → Die zarten Nebelschleier, die sich am Morgen über der Lagune erheben und einem sanften, verträumten Licht Platz machen, lieferten die Inspiration für die Hängelampe Caiigo. „Caiigo“ bedeutet im venezianischen Dialekt „Nebel“. Und tausende Jahre hat hier in der Lagunenstadt das mundgeblasene Glas Tradition, das für den Diffusor verwendet wird. Der charakteristische Farbverlauf der Leuchte von Weiß nach Transparent ist das Resultat meisterhafter Glasbläserkunst und macht jedes Stück einzigartig. Der Zauber und die Hochwertigkeit der handwerklichen Fertigung lassen ein poetisches Licht entstehen. Die gleichmäßig nach unten strahlende LED-Lichtquelle harmoniert dabei perfekt mit der emotionalen Qualität des mundgeblasenen Glases. Egal ob eingeschaltet oder ausgeschaltet verzaubert Caiigo durch ihre faszinierende Optik, verleitet zum Träumen und weckt Assoziationen an die Natur. Die vielseitige Leuchte eignet sich gleichermaßen für den Privat-, wie auch den Objektbereich. Schön als Einzelleuchte sowie in linearen oder traubenförmigen Kompositionen.

ESP → La visión que ha inspirado la lámpara de suspensión Caiigo es la neblina que se levanta por la mañana de la laguna, revelando una

luminosidad enrarecida y soñadora. "Caiigo" en dialecto veneciano significa niebla y de la milenaria tradición de la ciudad lagunar nace también el vidrio soplado utilizado para el difusor. Su característico efecto de color degradado, entre el blanco y el transparente, está determinado por la habilidad artesanal del maestro que consigue que cada lámpara sea única. La magia y el valor del proceso artesanal convierte en poesía la luz LED, que se irradia excelente hacia abajo, fundiéndose perfectamente con la emoción preciosa del vidrio soplado. La lámpara Caiigo, sugestiva tanto encendida como apagada, capaz de evocar sensaciones de la memoria y de la naturaleza, es una protagonista versátil en el paisaje doméstico y en los escenarios contract: sola, en composiciones lineares o formando un racimo.

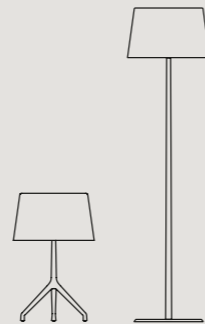

Lumière xxl + xxs —
Rodolfo Dordoni, 2009/2015
p. 010

FR → C'est en 1990 que le designer Rodolfo Dordoni

a proposé à Foscarini une relecture brillante, élégante et créative de l'abat-jour classique. Cette rencontre a donné naissance à Lumière, aujourd'hui encore une des meilleures ventes de la collection et icône dans le paysage du design contemporain. La première Lumière a ensuite inspiré les versions XXL et XXS, une relecture du projet d'origine, avec de nouvelles proportions et une empreinte plus incisive. Aujourd'hui, Lumière xxl et xxs se présente sous un nouveau jour, avec des couleurs actuelles qui en soulignent l'élégance recherchée et la rapprochent des tons des meubles contemporains. En plus de l'éternel blanc, le gris froid et le marron froid sont des propositions raffinées pour l'abat-jour en verre soufflé à la bouche, en combinaison avec les nouvelles finitions en aluminium brossé ou en chrome noir pour la monture. La nouvelle Lumière xxl de lecture est en revanche une expression d'une recherche entièrement nouvelle dans ses proportions, ses dimensions et son langage esthétique. Elle maintient son dualisme entre le diffuseur en verre soufflé et la base en métal, se coordonne avec la nouvelle palette de la version de table mais en redessine l'harmonie en créant une nouvelle présence dans l'espace : importante mais pas envahissante, élégante mais pas ostentatoire, elle est particulièrement adaptée aux séjours.

DE → Im Jahr 1990 machte der Designer Rodolfo Dordoni Foscarini den Vorschlag, eine kultivierte, elegante und kreative Neuinterpretation der klassischen Tischlampe zu schaffen. Daraus entstand Lumière, noch heute ein Bestseller der Kollektion und eine Ikone des modernen Designs. Die erste Lumière inspirierte später die Versionen xxl und xxs, Neuinterpretationen des Originalentwurfs mit neuen Proportionen und einem energischeren Ausdruck. Heute präsentieren sich Lumière xxl und xxs in einem neuen Aussehen, in zeitgemäßen Farben, die die ausgesuchte Eleganz unterstreichen und sie an den Ausdruck zeitgenössischer Einrichtungsstile annähern. Neben dem üblichen Weiß sind kaltes Grau und kaltes Braun die raffinierten neuen Farben für den Lampenschirm aus mundgeblasenem Glas, der mit den neuen Oberflächen aus gebürstetem Aluminium oder schwarzem Chrom für die Fassung kombiniert wird. Die neue Lumière xxl Leseleuchte ist dagegen Ausdruck der Suche nach gänzlich neuen Proportionen, Dimensionen und ästhetischen Formgebungen. Diese Leuchte drückt das Spannungsfeld zwischen dem Diffusor aus geblasenem Glas und der Fassung aus Metall aus, sie ist Teil der neuen Palette von Tischleuchten und definiert die Harmonie neu, indem sie eine neue Präsenz im

Raum schafft: imposant aber nicht aufdringlich und von zurückhaltender Eleganz, geeignet vor allem für den Wohnbereich.

ESP → Corría el 1990 cuando el diseñador Rodolfo Dordoni propuso a Foscarini una nueva interpretación culta, elegante y creativa de la clásica pantalla. De ese encuentro nació Lumière, actualmente todavía best seller de la colección e icono en el panorama del diseño contemporáneo. La primera Lumière inspiró a continuación las versiones xxl y xxs, una nueva interpretación del proyecto original, de proporciones nuevas y de rasgo más atrevido. Actualmente Lumière xxl y xxs se presentan con un aspecto renovado, con colores actuales que destacan su elegancia sofisticada y la acercan a los tonos del mobiliario contemporáneo. Al lado del blanco de siempre, gris frío y marrón frío son las refinadas propuestas para la pantalla en vidrio soplado a boca, que combina con los nuevos acabados en aluminio cepillado o cromo negro para la montura. En cambio, la nueva Lumière xxl de lectura representa la expresión de una búsqueda completamente nueva en las proporciones, el tamaño y el lenguaje estético. Mantiene el dualismo entre el difusor en vidrio soplado y la base en metal, se combina con la nueva paleta de la versión de mesa pero con una nueva armonía, creando una

nueva presencia en el espacio: importante pero discreta, elegante pero sin ostentación, adaptar a los ambientes de día.

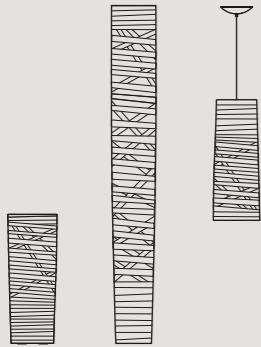

Tress —
Marc Sadler, 2008/2009
p. 018

FR → Tress est un croisement qui devient à la fois une structure porteuse et un décor, en donnant forme à une idée d'éclairage original, déjà iconique dans le paysage du design de la lumière. Pur jeu de pleins et de vides, de lumières et d'ombres, Tress est obtenue par un processus artisanal. L'enroulement de rubans en matériau composite, qui suit un motif apparemment aléatoire, permet d'obtenir une forme qui apporte à l'espace une atmosphère chaude et magique. Aujourd'hui ce projet se pare de nouvelles tonalités. Volcanique en rouge cramoisi, surprenante en bleu indigo et très actuelle en greige, un ton entre le gris et le beige, Tress offre de nouvelles nuances aux habitations et aux espaces collectifs. Les nouvelles couleurs sont complétées par le blanc et le noir, composant

ainsi un choix parmi cinq possibilités, chacune avec son propre charme. Le résultat est une grande famille de lampes, particulièrement adaptées aux grandes compositions multiples ou aux projets d'éclairage coordonnés.

DE → Tress besteht aus einem Geflecht, das zugleich tragende Struktur und Dekor ist. Diese Leuchte verkörpert die Idee der ursprünglichen Beleuchtung und ist schon eine Ikone im Lichtdesign. Tress spielt mit dem Kontrast zwischen Fülle und Leere, Licht und Schatten und wird von Hand gefertigt. Mit Bändern aus Verbundmaterial, die in einem scheinbar zufälligen Muster gewickelt sind, entsteht eine Form, die im Raum eine warme und magische Atmosphäre verbreitet. Heute ist dieser Entwurf in neuen Farben erhältlich. Tress präsentiert sich vulkanähnlich in Karmesinrot, außergewöhnlich in Indigoblau oder brandaktuell in Greige – einem Farbton zwischen Grau und Beige – und bringt neue Nuancen in Wohnungen und öffentliche Räume. Neben den neuen Farben ist Tress auch in Weiß und Schwarz erhältlich, es bieten sich somit fünf verschiedene Varianten, jede mit ihrem eigenen Reiz. Das Ergebnis ist eine große Lampenfamilie, ideal für Kompositionen aus mehreren Leuchten oder für Beleuchtungsprojekte.

ESP → Tress es una trama

que se convierte al mismo tiempo en estructura portante y decoración, dando forma a una idea de iluminación original, que ya es un icono en el panorama del diseño de la luz. Puro juego de llenos y vacíos, luces y sombras, Tress se obtiene mediante un proceso artesanal. Del enrollamiento de cintas en material composite, siguiendo un motivo aparentemente casual, se obtiene una forma que difunde en el espacio una atmósfera cálida y mágica. Actualmente este proyecto se viste con nuevas tonalidades. Volcánica en rojo carmesí, sorprendente en azul índigo y sumamente actual en crudo – un tono entre el gris y el beige – Tress trae consigo nuevos matices en los hogares y en los espacios colectivos. Los nuevos colores se acompañan con el blanco y el negro, componiendo una selección entre cinco diversas posibilidades, cada una con un encanto especial. El resultado es una amplia familia de lámparas, especialmente adecuada para grandes composiciones múltiples o para proyectos de iluminación coordinados.

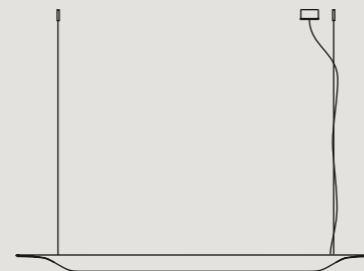

Troag —
Luca Nichetto, 2010
p. 032

FR → De par son nom et de par sa forme, Troag s'inspire d'un bol en bois de la tradition scandinave, un objet familier et quotidien. Une inspiration replacée dans le contexte par Foscarini et Luca Nichetto avec créativité, recherche technologique et minutie dans sa réalisation typiquement italienne. Lampe à suspension à l'empreinte légère et linéaire, Troag habille une lumière technique avec la chaleur du bois. Le diffuseur est réalisé en multicouche cintré à chaud et travaillé sur les bords avec un fraisage particulier. Disponible en trois différentes mesures, Troag exploite au mieux la luminosité du tube fluorescent à l'intérieur en projetant vers le bas une lumière chaude et uniforme, qui n'éblouit pas grâce à un écran de protection. Les finitions naturelle et noire sont aujourd'hui complétées par une nouvelle version blanche, qui laisse entrevoir les nervures du bois. Une finition qui met en valeur l'inspiration nordique et les lignes essentielles de Troag, tout en s'harmonisant avec une tendance dominante dans l'ameublement contemporain. Troag s'intègre à tout espace et à toute situation : d'une cuisine à une salle à manger en passant par un bureau.

DE → Im Namen wie in der Form orientiert sich Troag an einer traditionellen skandinavischen Holzschale, einem vertrauten und

alltäglichen Gegenstand. Eine Inspiration, die von Foscarini und Luca Nichetto mit der Kreativität, technischen Erfahrung und Sorgfalt bei der Umsetzung, die so typisch italienisch sind, in einen neuen Kontext gestellt wurde. Troag ist eine Hängeleuchte mit leichter und linearer Formgebung und verbindet technisches Licht mit der Wärme des Holzes. Der Diffusor besteht aus warm geformtem Mehrschichtholz, dessen Ränder mit einer besonderen Fräsung bearbeitet sind. Troag ist in drei Größen erhältlich. Das Licht der Leuchtstoffröhre im Inneren wird optimal genutzt und als warmes und gleichmäßiges Licht nach unten abgestrahlt, durch den Schutzschild bietet Troag ein blendfreies Licht. Neben den Farben Natur und Schwarz ist die Leuchte jetzt auch in Weiß mit durchscheinender Holzmaserung erhältlich. Diese Farbe betont die skandinavische Inspiration und die Hauptlinien von Troag und stellt sie in Einklang mit einem wichtigen Trend des zeitgenössischen Einrichtungsstils. Troag ist für jeden Raum und jede Situation passend: für die Küche, das private Esszimmer oder das Home Office.

ESP → En el nombre y en la forma, Troag se inspira en un cuenco de madera de la tradición escandinava, un objeto familiar y cotidiano. Una inspiración readaptada

por Foscarini y Luca Nichetto con creatividad, investigación tecnológica y la típica atención italiana en la realización. Troag, lámpara de suspensión de rasgo ligero y lineal, utiliza una luz técnica con el calor de la madera. El difusor, en efecto, se ha realizado en multicapa curvada en caliente y se ha trabajado en los bordes con un especial fresado. Troag, que se encuentra disponible en tres medidas, aprovecha de la mejor forma posible la luminosidad del tubo fluorescente en el interior, proyectando hacia abajo una luz cálida y uniforme, que no deslumbra gracias a una pantalla protectora. A los acabados natural y negro, se añade ahora una nueva versión blanca, que deja entrever las vetas de la madera. Un acabado que destaca la inspiración nórdica y las líneas esenciales de Troag, entrando en sintonía con una tendencia dominante en el mobiliario contemporáneo. Troag se adapta a cualquier espacio y situación: desde una cocina a un comedor doméstico y a un despacho en casa.

Legenda — Key

LED

Identifica i modelli con LED integrati e già inclusi, risultato della progettazione ed ingegnerizzazione Foscarini.

It marks the models with integrated LED included in the lamp, which is the result of Foscarini designing and engineering.

LED Retrofit

Identifica la possibilità di utilizzare una lampadina LED retrofit standard comunemente disponibile sul mercato.

It marks the possibility of using a standard retrofit LED bulb available on the market.

Classe I

Apparecchio in classe I°: è obbligatoria la connessione al conduttore di protezione giallo / verde (messa a terra).

Class I° luminaire: it's necessary to connect the device to the yellow / green protective conductor (earthing).

Classe II

Apparecchio in cui la protezione contro la scossa elettrica si basa unicamente sul doppio isolamento e/o isolamento rinforzato in ogni parte e senza dispositivo di messa a terra.

Light fittings whose safety is guaranteed only by the double and/or reinforced insulation of all parts, with no earth.

ENEC

Il marchio ENEC (Certificazione Elettrica relativa alle Norme Europee) è un marchio volontario rilasciato da enti terzi. Certifica che il prodotto è conforme e rispetta i requisiti proposti dalla norma EN 60598 ed è progettato e realizzato in aziende il cui sistema di gestione della qualità soddisfa i requisiti della norma UNI EN ISO 9001.

The label ENEC (Electrical Certification concerning European Standard) is a voluntary label granted by third organizations. It certifies that a product complies with the EN 60598 standards and has been designed and manufactured by companies with an approved UNI EN ISO 9000 quality control system.

cULus

Certifica che il prodotto è conforme e rispetta i requisiti proposti dalle normative nordamericane, viene rilasciato dall'UL, organizzazione indipendente leader nel settore della certificazione di sicurezza dei prodotti destinati al mercato Nordamericano.

Certifies that the product is conform to the North American standards, and is issued by UL, independent organisation leader in the field of products safety certification for the North American market.

IP Protection Degree

IP20: apparecchio protetto contro la penetrazione di corpi solidi di dimensioni maggiori a 12mm e non protetto nei confronti dei liquidi.

IP20: protected against the penetration of solid objects greater than 12 mm and non protected against liquids.

CCC

The China Compulsory Certificate mark certifies that the product is conform to the Chinese standards.

The China Compulsory Certificate mark certifies that the product is conform to the Chinese standards.

Energy Efficiency Classes

Le classi di efficienza energetica degli apparecchi luminosi, definite dal reg. UE n.874/2012, sono determinate in base all'Indice di Efficienza Energetica (IEE) e spaziano in un intervallo compreso tra A++ (efficienza massima) ed E (efficienza minima).

The energy efficiency classes for light appliances set out by EU regulation no. 874/2012 are calculated on the basis of the Energy Efficiency Index (EEI) and range between A++ (maximum efficiency) and E (minimum efficiency).

CSQ - IQNET

Marchio valido in tutto il mondo, certifica che l'azienda Foscarini attua un sistema di gestione della qualità conforme alla normativa UNI EN ISO 9001:2008, per garantire un elevato standard qualitativo nella progettazione, sviluppo, fabbricazione e commercializzazione dei propri prodotti.

The CSQ-IQNET label is valid all over the world. It certifies that Foscarini runs a quality management system which complies with the UNI EN ISO 9001:2008 standard, to guarantee a high quality level for what concerns project, development, production and distribution of its products.

CSQ ECO

Marchio valido in tutto il mondo, certifica che l'azienda Foscarini attua un sistema di gestione ambientale conforme alla normativa UNI-EN ISO 14001:2004 per garantire l'impegno dell'azienda ad operare nel rispetto dell'ambiente e con l'obiettivo continuo di ridurre l'impatto delle proprie attività.

This label is valid all over the world. It certifies that Foscarini runs an environmental management system which complies with the UNI EN ISO 14001:2004 standard in order to guarantee company's commitment to continual improvement of its environmental performances.

Colophon

Foscarini SpA
via delle Industrie 27
30020 Marcon / Venezia / Italy
T +39 041 595 3811
F +39 041 595 3820
foscarini@foscarini.com

Foscarini Inc
17 Greene Street, New York
NY /10013 / USA
T +1 212 247 2218
F +1 646 545 2564
foscarini.inc@foscarini.com

Foscarini Spazio Brera
via Fiori Chiari 28 /
via Pontaccio 19
20121 / Milano / Italy
T +39 02 870 71320
spaziobrera@foscarini.com

Foscarini Spazio Soho
17 Greene Street, New York
NY /10013 / USA
T +1 212 257 4412
spaziosoho@foscarini.com

Azienda certificata
UNI EN ISO 9001
UNI EN ISO 14001



edizione 01.2016

Concept and graphic design:
Designwork
art direction: Artemio Croatto
art work: Erika Pittis / Designwork

Styling: Elisa Ossino Studio

Photography:
Massimo Gardone / Azimut
Tommaso Sartori → p. 040.
Kasia Gatkowska → p. 002, 010.

Thanks to:
Opinion Ciatti, ILtavolo

Colour separation:
Luce, Udine
made and printed in Italy
by Grafiche GFP, Azzano Decimo

foscarini.com

FOSCARINI